

**BY-LAWS (Code of Regulations) of
DORSET GLEN CONDOMINIUM ASSOCIATION**

ARTICLE I

NAME AND LOCATION

The name of the Association is Dorset Glen Condominium Association, ("the Association"), which corporation, not-for-profit, is created pursuant to the provisions of Chapter 1702 of the Revised Code of Ohio, and which Association is also created pursuant to the provisions of Chapter 5311 of the Revised Code of Ohio as the unit owners' association for Dorset Glen Condominium. The principal office of the Association shall be as set forth in its Articles of Incorporation, ("the Articles"), and the place of meetings of Unit owners (members) and of the Directors (Board of Managers) of the Association shall be at such place in Franklin County, Ohio as the Board of Directors ("the Board"), may from time to time designate.

ARTICLE II

DEFINITIONS

All of the terms used herein shall have the same meanings as set forth in the Declaration of Dorset Glen Condominium, ("the Declaration"), recorded simultaneously herewith with the Recorder of Franklin County, Ohio.

ARTICLE III

UNIT OWNERS (MEMBERS)

Section 1. Composition. Each Unit owner, as defined in the Declaration, is a member of the Association.

Section 2. Annual Meetings. Regular annual meetings of the Unit owners shall be held in the first calendar quarter of each year hereafter, on a date and at an hour established, from time to time, by the Board.

Section 3. Special Meetings. Special meetings of the Unit owners may be called at any time by the president or by the Board, upon written request of Unit owners entitled to exercise one-fourth (1/4) or more of the voting power of Unit owners, and when required by the Condominium act.

Section 4. Notice of Meetings. Written notice of each meeting of Unit owners shall be given by, or at the direction of, the secretary or person authorized to call the

meeting, by mailing a copy of such notice, postage prepaid, at least five days before such meeting, to each Unit owner entitled to vote thereat, addressed to the Unit owner's address last appearing on the books of the Association, or supplied by such Unit owner to the Association for the purpose of notice, or by delivering a copy of that notice at such address at least five (5) days before the meeting. The notice shall specify the place, day and hour of the meeting, and, in the case of a special meeting, the purpose of the meeting.

Section 5. Quorum. The Unit owners present, in person or by proxy, at any duly called and noticed meeting of Unit owners, shall constitute a quorum for such meeting. Unit owners entitled to exercise a majority of the voting power of Unit owners represented at a meeting may, at any time, adjourn such meeting. If any meeting is so adjourned, notice of such adjournment need not be given if the time and place to which such meeting is adjourned are fixed and announced at such meeting.

Section 6. Proxies. At any meeting of Unit owners, a Unit owner may vote in person or by proxy. All proxies shall be in writing and filed with the secretary prior to the meeting. Every proxy shall be revocable and shall automatically cease upon conveyance by a Unit owner of his, her or its Unit.

Section 7. Voting Power. Except as otherwise provided in the Condominium organizational documents, or by law, a majority of the voting power of Unit owners voting on any matter that may be determined by the Unit owners at a duly called and noticed meeting shall be sufficient to determine that matter. The rules of Roberts Rules of Order shall apply to the conduct of all meetings of Unit owners except as otherwise specifically provided in the Condominium organizational documents or by law.

Section 8. Action In Writing Without Meeting. Any action that could be taken by Unit owners at a meeting may be taken without a meeting with the affirmative vote or approval, in a writing or writings, of Unit owners having not less than a majority of the voting power of Unit owners, or such greater proportion of the voting power as may be required by the Condominium organizational documents, or by law.

ARTICLE IV

BOARD OF DIRECTORS: (BOARD OF MANAGERS)

Section 1. Initial Directors. The initial Directors shall be those three persons named as the initial Directors in the Articles, or such other person or persons as may from time to time be substituted by the Declarant.

Section 2. Successor Directors. The number, times of election, and terms of office of those who will serve as Directors of the Association to succeed the initial Directors, shall be as provided in the Declaration and these By-Laws.

Section 3. Removal. Excepting only Directors named in the Articles or selected by Declarant, any Director may be removed from the Board with or without cause, by a majority vote of the Unit owners. In the event of the death, resignation or removal of a Director other than one named in the Articles or a substitute selected by the Declarant, that Director's successor shall be selected by the remaining members of the Board and shall serve until the next annual meeting of Unit owners, when a Director shall be elected to complete the term of such deceased, resigned or removed Director. Declarant shall have the sole right to remove, with or without cause, any Director designated in the Articles, or a substitute selected by the Declarant, and select the successor of any Director so selected who dies, resigns, is removed or leaves office for any reason before the election of Directors by all of the Unit Owners as provided in the Declaration.

Section 4. Nomination. Nominations for the election of Directors to be elected by the Unit owners shall be made by a nominating committee. Nominations may also be made from the floor at the meetings. The nominating committee shall consist of a chairman, who shall be a member of the Board, and two or more Unit owners appointed by the Board. The nominating committee shall make as many nominations for election to the Board as it shall, in its discretion, determine, but no less than the number of vacancies that are to be filled.

Section 5. Election. Election to the Board by the Unit owners shall be by secret written ballot. At such elections, the Unit owners or their proxies may cast, in respect to each vacancy, such voting power as they are entitled to exercise under the provisions of the Declaration. The persons receiving the largest number of votes shall be elected, and likewise, those receiving the largest number of votes shall be elected to the longest terms. Cumulative voting is not permitted.

Section 6. Compensation. Unless otherwise determined by the Unit owners at a meeting duly called and noticed for such purpose, no Director shall receive compensation for any service rendered to the Association as a Director. However, any Director may be reimbursed for his or her actual expenses incurred in the performance of duties.

Section 7. Regular Meetings. Regular meetings of the Board shall be held no less than quarterly, without notice, on such date and at such place and hour as may be fixed from time to time by resolution of the Board.

Section 8. Special Meetings. Special meetings of the Board shall be held when called by the president of the Board, or by any two Directors, after not less than three days notice to each Director.

Section 9. Quorum. The presence at any duly called and noticed meeting, in person or by proxy, of Directors entitled to cast a majority of the voting power of Directors shall constitute a quorum for such meeting.

Section 10. Voting Power. Except as otherwise provided in the Condominium organizational documents, or by law, vote of a majority of the Directors voting on any matter that may be determined by the Board at a duly called and noticed meeting at which a quorum is present shall be sufficient to determine that matter.

Section 11. Action In Writing Without Meeting. Any action that could be taken by the Board at a meeting may be taken without a meeting with the affirmative vote or approval, in a writing or writings, of all of the Directors.

Section 12. Powers. The Board shall exercise all powers and authority, under law, and under the provisions of the Condominium organizational documents, that are not specifically and exclusively reserved to the Unit owners by law or by other provisions thereof, and without limiting the generality of the foregoing, the Board shall have the right, power and authority to:

- (a) take all actions deemed necessary or desirable to comply with all requirements of law, and the Condominium organizational documents;
- (b) obtain insurance coverage no less than that required pursuant to the Declaration;
- (c) enforce the covenants, conditions and restrictions set forth in the Declaration;
- (d) repair, maintain and improve the Common Areas;
- (e) establish, enforce, levy and collect assessments as provided in the Declaration;
- (f) adopt and publish rules and regulations governing the use of the Common Areas and the personal conduct of Unit owners, occupants and their guests thereon, and establish penalties for the infraction thereof;

- (g) suspend the voting rights of a Unit owner during any period in which such Unit owner shall be in default in the payment of any assessment levied by the Association (such rights may also be suspended after notice and hearing, for a period not to exceed sixty (60) days for each infraction of published rules and regulations or of any provisions of the Condominium organizational documents);
 - (h) declare the office of a member of the Board to be vacant in the event such Director shall be absent from three consecutive regular meetings of the Board;
 - (i) authorize the officers to enter into one or more agreements necessary or desirable to fulfill the purposes and objectives of the Association and to facilitate the efficient operation of the property; (it shall be the primary purpose of such management agreements to provide for administration, management, repair and maintenance as provided in the Declaration, and the receipt and disbursement of funds as may be authorized by the Board. The terms of any management agreements shall be as determined by the Board to be in the best interest of the Association, subject, in all respects, to the provisions of the Condominium organizational documents);
-
- (j) cause funds of the Association to be invested in such reasonable investments as the Board may from time to time determine;
 - (k) borrow funds, as needed, and pledge such security and rights of the Association as might be necessary or desirable to obtain any such loan including, without limitation, the pledge of the Association's right to levy assessments upon the members; and
 - (l) do all things and take all actions permitted to be taken by the Association by law, or the Condominium organizational documents not specifically reserved thereby to others.

Section 13. Duties. It shall be the duty of the Board to:

- (a) cause to be kept a complete record of all its acts and corporate affairs and to present a statement thereof to the Unit owners at each annual meeting of Unit owners, or at

- any special meeting when such statement is requested in writing by Unit owners representing one-half (1/2) or more of the voting power of Unit owners;
- (b) supervise all officers, agents and employees of the Association and see that their duties are properly performed;
 - (c) as more fully provided in the Declaration, to:
 - (i) fix the amount of assessments against each Unit;
 - (ii) give written notice of each assessment to every Unit owner subject thereto within the time limits set forth therein; and
 - (iii) foreclose the lien against any property for which assessments are not paid within a reasonable time after they are authorized by the Declaration to do so, or bring an action at law against the Unit owner(s) personally obligated to pay the same, or both;
 - (d) issue, or to cause an appropriate representative to issue, upon demand by any person, a certificate setting forth whether or not any assessment has been paid;
 - (e) procure and maintain insurance and bonds as provided in the Declaration; and as the Board deems advisable;
 - (f) cause the property subject to the Association's jurisdiction to be maintained within the scope of authority provided in the Declaration;
 - (g) cause the restrictions created by the Declaration to be enforced; and
 - (h) take all other actions required to comply with all requirements of law and the Condominium organizational documents.

ARTICLE V

OFFICERS

Section 1. Enumeration of Offices. The officers of this Association shall be a president, a secretary, a treasurer and such other officers as the Board may from time to time determine. No officer need be a member of the Association nor need any officer be a Director. The same person may hold more than one office.

Section 2. Selection and Term. Except as otherwise specifically provided in the Declaration or by law, the officers of the Association shall be selected by the Board, from time to time, to serve until the Board selects their successors.

Section 3. Special Appointments. The Board may elect such other officers as the affairs of the Association may require, each of whom shall hold office for such period, have such authority, and perform such duties as the Board may, from time to time, determine.

Section 4. Resignation and Removal. Any officer may be removed from office, with or without cause, by the Board. Any officer may resign at any time by giving written notice to the Board, the president, or the secretary. Such resignation shall take effect on the date of receipt of such notice or at any later time specified therein, and the acceptance of such resignation shall not be necessary to make it effective.

Section 5. Duties. The duties of the officers shall be as the Board may from time to time determine. Unless the Board otherwise determines, the duties of the officers shall be as follows:

- (a) **President.** The president shall preside at all meetings of the Board, shall have the authority to see that orders and resolutions of the Board are carried out, and shall sign all legal instruments on behalf of the Association.
- (b) **Secretary.** The secretary shall record the votes and keep the minutes and proceedings of meetings of the Board and of the Unit owners, serve notice of meetings of the Board and of the Unit owners, keep appropriate current records showing the names of Unit owners of the Association together with their addresses, and shall act in the place and stead of the president in the event of the president's absence or refusal to act.
- (c) **Treasurer.** The treasurer shall assume responsibility for the receipt and deposit in such bank accounts and investment.

of funds in such vehicles, as the Board directs, the disbursement of such funds as directed by the Board, the keeping of proper books of account, the preparation of an annual budget and a statement of income and expenditures to be presented to the Unit owners at annual meetings, and the delivery or mailing of a copy of each to each of the Unit owners.

ARTICLE VI

COMMITTEES

The Board shall appoint a nominating committee and may appoint such other committees as it deems appropriate in carrying out its purposes.

ARTICLE VII

BOOKS AND RECORDS

The books, records and financial statements of the Association, including annual audited financial statements when such are prepared, shall be available during normal business hours or under other reasonable circumstances, upon request to the Association, for inspection by Unit owners, holders, insurers and guarantors of first mortgages on Units. Likewise, during normal business hours or under other reasonable circumstances, the Association shall have available for inspection by Unit owners, holders, insurers and guarantors of first mortgages on Units, and prospective purchasers, current copies of the Condominium organizational documents and the rules and regulations governing operation of the Condominium.

ARTICLE VIII

AUDITS

The Board shall cause the preparation and furnishing of an audited financial statement for the immediately preceding fiscal year, within a reasonable time following request (provided that no such statement need be furnished earlier than ninety days following the end of such fiscal year), in the following circumstances:

1. to each requesting Unit owner, at the expense of the Association, upon the affirmative vote of Unit owners exercising a majority of the voting power of Unit owners; and

2. upon the request of a holder, insurer, or guarantor of any first mortgage on a Unit.

ARTICLE IX

FISCAL YEAR

Unless otherwise changed by the Board, the fiscal year of the Association shall begin on the first day of January and end on the 31st day of December of every year, except that the first fiscal year shall begin on the date of incorporation of this Association.

ARTICLE X

AMENDMENTS

Any modification or amendment of these By-Laws shall be made only by means of an amendment to the Declaration, in the manner and subject to the approvals, terms and conditions set forth therein, and shall be effective from the time a certificate setting forth such modification or amendment is delivered for recording to the Recorder of the county in which the Condominium is located.

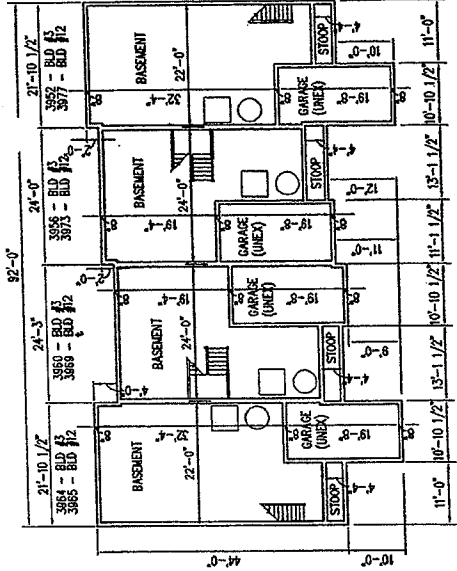

FOUNDATION PLAN
1/16" = 1'-0"

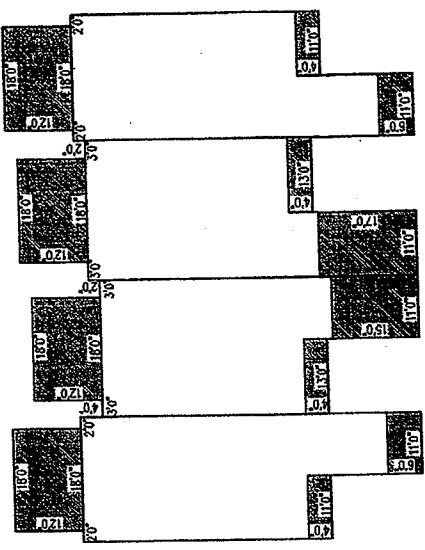

LIMITED COMMON AREA DIAGRAM
NTS

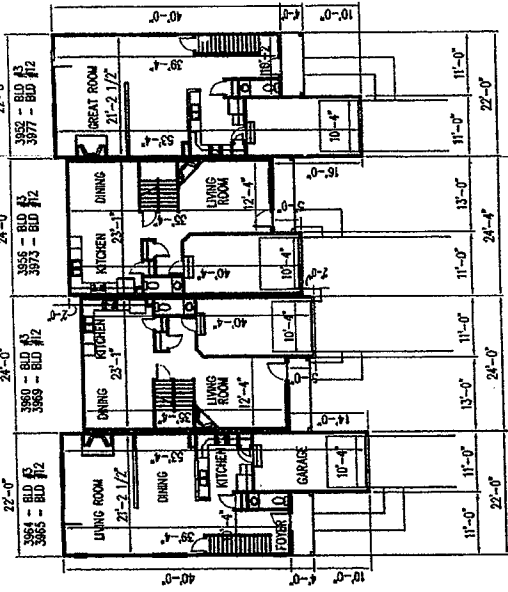

FIRST FLOOR PLAN
- OUTSIDE WALLS ARE 4"
- DIMENSIONS TYPICAL FOR ALL SIMILAR UNITS
1/16" = 1'-0"

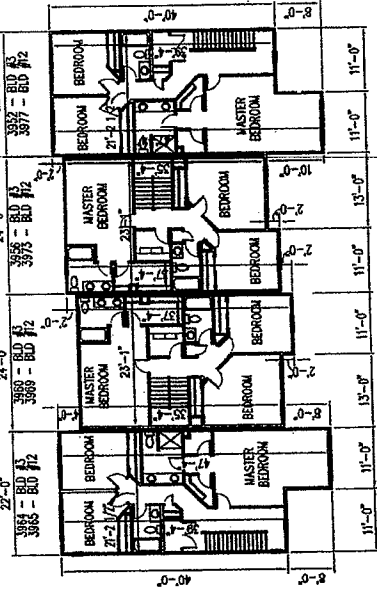

SECOND FLOOR BUILDING PLAN
1/16" = 1'-0"

- OUTSIDE WALLS ARE 4"
- DIMENSIONS TYPICAL FOR ALL SIMILAR UNITS

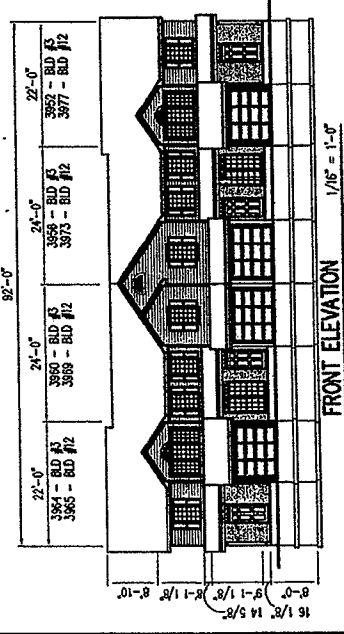

FRONT ELEVATION
1/16" = 1'-0"

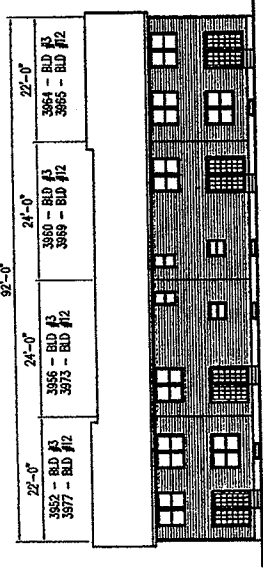

REAR ELEVATION
1/16" = 1'-0"

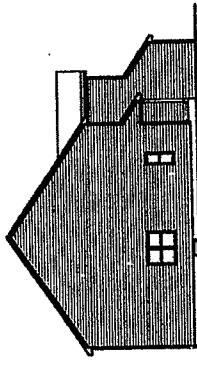

LEFT SIDE ELEVATION
1/16" = 1'-0"

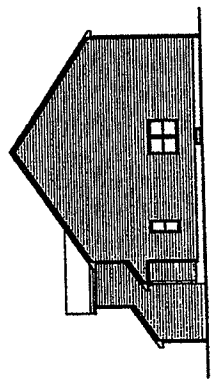

RIGHT SIDE ELEVATION
1/16" = 1'-0"

HASBROUCK ENGINEERING, INC.
CONSULTING ENGINEERS
1080 KINGSKILL PARKWAY - SUITE 110 - COLUMBUS, OHIO 43269

KBS DARBY PARK, LLC
900 W. THIRD AVE
P.O. BOX 12341
COLUMBUS, OH 43212

scale: 1/16" = 1'-0" approved by: dh
date: 12/02/02 drawing no.: 2002385
job no.: 2002385

AUDITORS PLAN 2 of 2

INTERIOR WALL THICKNESS:
WITHIN UNIT = 4 1/2"
BETWEEN UNITS = 10"

GRAPHIC SCALE

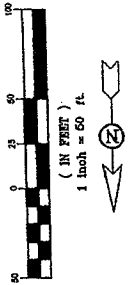

Wellington Housing Partners, Inc.
5.996 Ac.
Inst. No. 20011150264445

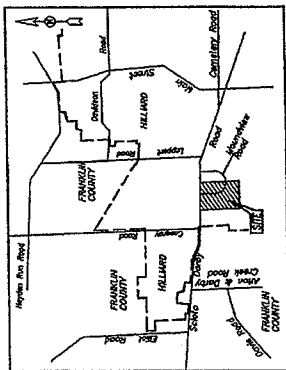

LOCATION MAP

20' Wide City of Hilliard Utility Easement
Inst. No. 200001030000839

20' Wide City of Hilliard Utility Easement
Inst. No. 200001030000834

- LEGEND**
- RRP Reinforced Stake - Found
 - RRS Reinforced Stake - Set
 - RF 3/4" - 1/4" (60) Iron Pipe - Found
 - RF 3/4" - 1/4" (60) Iron Pipe - Set
 - RS 3/4" - 1/4" (60) Iron Pipe - Set
 - ULS Limited Common Area
 - UNB Building Number
 - UNL Unit Number

All Areas not designated as Limited Common Areas are Limited Designation Common Areas. Limited Common Driveway Areas not yet completed.

Franklin County Monument
FOSS 5540

POSTGRADY ROAD

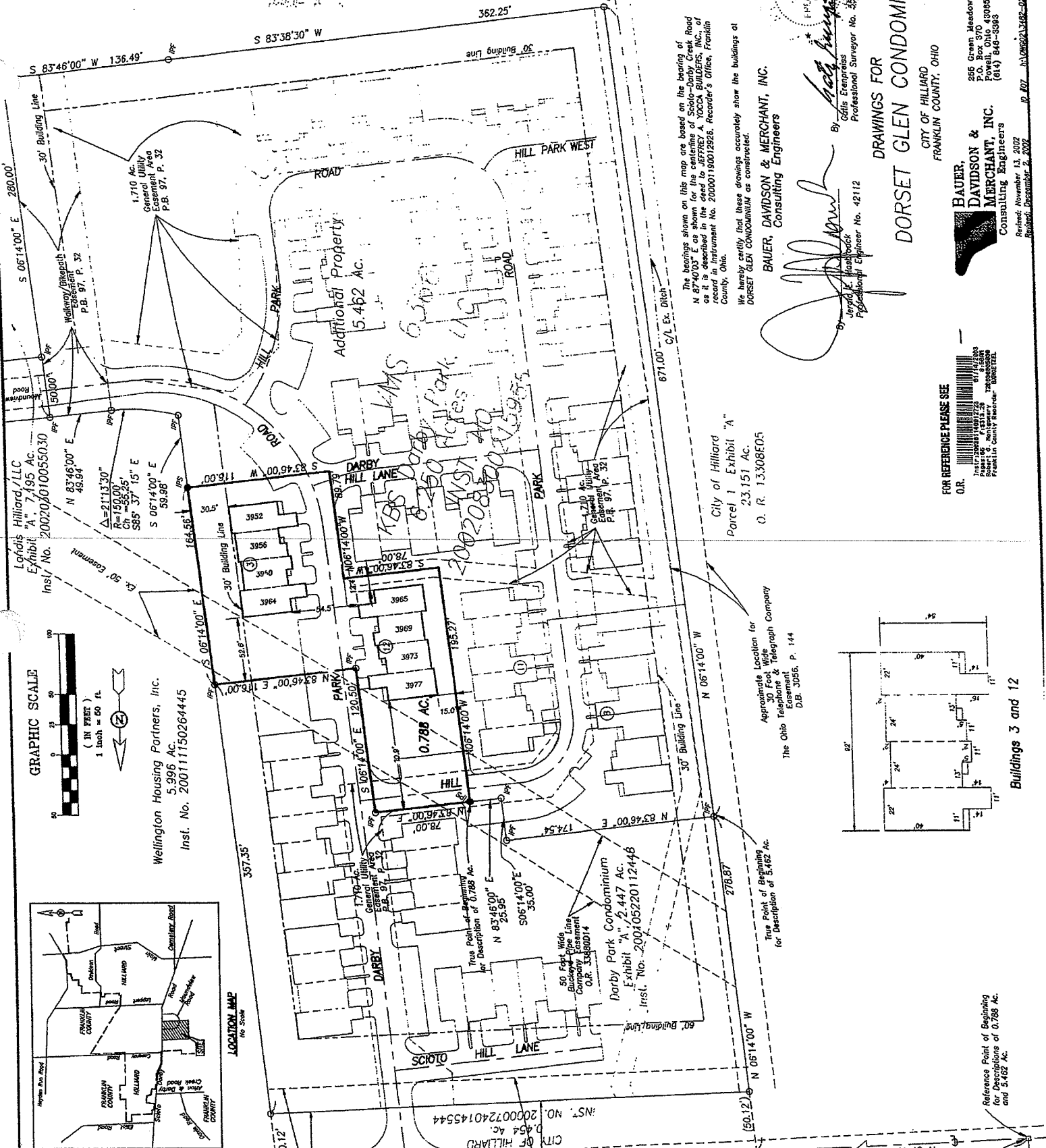

Liquidis Hilliard, LLC
Exhibit "A", 7.195 Ac.
Inst. No. 200207010055030

Additional Property
5.462 Ac.

Darby Park Condominium
Exhibit "A", 2.447 Ac.
Inst. No. 200405220112446

Parcel 1 Exhibit "A"
23.151 Ac.
O. R. 13308E005

City of Hilliard
Parcel 1 Exhibit "A"
23.151 Ac.
O. R. 13308E005

Approximate Location for
The Ohio Telephone & Telegraph Company
Easement
D.B. 3056, P. 144

True Point of Beginning
for Description of 0.788 Ac.
for Description of 5.462 Ac.

Reference Point of Beginning
for Description of 0.788 Ac.
and 5.462 Ac.

FOR REFERENCE PLEASE SEE
O.R.
Inst. No. 20011150264445
Page 16 of 16
Inst. No. 20011150264445
Page 16 of 16
Inst. No. 20011150264445
Page 16 of 16

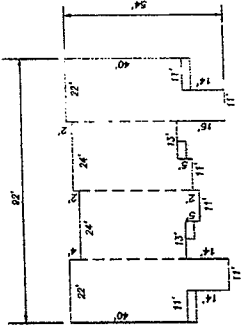

Buildings 3 and 12

The bearings shown on this map are based on the bearing of N 87° 40' 32" W as shown for the centerline of Scoto-Darby Creek Road as it is described in the deed to JEFFREY A. YODCA BUILDERS, INC., of record in instrument No. 20000190012926, Recorder's Office, Franklin County, Ohio.

We hereby certify that these drawings accurately show the buildings at DORSET GLEN CONDOMINIUM as constructed.

BAUER, DAVIDSON & MERCHANT, INC.
Consulting Engineers

By *[Signature]*
Cedric E. Henschel
Professional Engineer No. 42112

By *[Signature]*
Cedric E. Henschel
Professional Engineer No. 42112

DRAWINGS FOR
DORSET GLEN CONDOMINIUM

CITY OF HILLIARD
FRANKLIN COUNTY, OHIO



266 Green Meadows Drive S.
P.O. Box 370 43005
(614) 644-3393

Revised: November 13, 2002
Revised: December 2, 2002